

2015 RAM 1500



PLAYS HARD

**THE BEST OF
BOTH WORLDS**



WORKS HARDER



DEPENDABLE + SENSIBLE

Properly secure all cargo.



RAM 1500. THE PICKUP THAT BRINGS IT ALL TOGETHER. These are the combinations that define leadership: one of the most extensive powertrain lineups in the industry, standing out with exceptional fuel efficiency, jaw-dropping towing and payload numbers for invaluable work capability—and priceless peace of mind for those demanding recreational needs. Nimble agility and responsive comfort for highways, off-roads and even at-rest loading. Class-exclusive^{[1]*} suspensions. State-of-the-art technology. And people-centric interiors that give you seating, storage, communications and telematics at impressive levels of convenience and practicality.

The 2015 Ram 1500 delivers a sleek aerodynamic exterior, legendary components and quality so good, it's backed by a 5-Year/100,000-Mile Powertrain Limited Warranty,^[2] one of the best in the business.

When you deliver all the refinements of a Ram, comparisons to the wannabe competitors are welcome. The 2015 Ram 1500 stands up to all of them—and frequently stands above. For a bigger picture that includes specs, videos, blogs and owner input, click over and bookmark **RAMTRUCKS.COM**

*A note about this brochure: all disclaimers and disclosures can be found on the back page.

RAM. ECONOMY + POWER

3.6L PENTASTAR® V6 – 25 MPG HWY*
THIS V6 RULES
305 HP/269 LB-FT OF TORQUE



BEST-IN-CLASS^[3] 25 MPG HIGHWAY* MAKES THIS ENGINE A GIANT.

Ram pickups made history by combining the capable efficiency of the Pentastar V6 with the first-ever truck application of an 8-speed automatic transmission, the class-exclusive^[1] TorqueFlite® 8-speed. Time has shown this partnership to be one of the best, a fact amply demonstrated by critical acclaim, back-to-back national awards, available 4x4 capability and indisputably impressive figures for towing and hauling. We then topped it off with a best-in-class^[3] 25 mpg highway* rating.

This exceptional powertrain utilizes some of the most powerful engineering practices and innovative technologies ever developed. When compared to conventional engines and transmissions, refinements to the Pentastar V6/TorqueFlite 8-speed powertrain lineup translate into what counts: awesome fuel efficiency and phenomenal performance.

BUILT FOR LONG-LIFE RELIABILITY: *From Day One, Pentastar V6 designers lasered in on achieving outstanding fuel efficiency. Assets here include a “Silent Chain” timing drive, dual overhead cams, high-flow “tumble” intake ports and a no-nonsense 10.2:1 compression ratio.*

BETTER BY SEVERAL DEGREES: *Both the Pentastar V6 engine and the TorqueFlite 8-speed transmission employ Thermal Management Systems. These systems keep fluids at ideal operating temperatures (surprisingly, slightly higher) for top-echelon numbers for horsepower, torque and fuel efficiency.*

PULSE-WIDTH MODULATION: *This maximizes the efficiency of electrical output. Rather than maintain a constant (and more inefficient) rate, the Pentastar V6 modulates the pulse-width of the energy. Result: better and more efficient control of the fuel pump, cooling fan and HVAC blower controls.*

*EPA estimated 17 mpg city/25 mpg hwy based on Ram 1500 3.6L V6 4x2.

3.6L PENTASTAR V6 CAPABILITY (WHEN PROPERLY EQUIPPED)



REGULAR CAB 6'4" BOX
7,310-LB MAX TOW CAPACITY
1,520-LB PAYLOAD CAPACITY



REGULAR CAB 8' BOX
7,260-LB MAX TOW CAPACITY
1,900-LB PAYLOAD CAPACITY



QUAD CAB® 6'4" BOX
7,600-LB MAX TOW CAPACITY
1,900-LB PAYLOAD CAPACITY



CREW CAB 5'7" BOX
7,480-LB MAX TOW CAPACITY
1,850-LB PAYLOAD CAPACITY

RAM. ECONOMY + POWER

5.7L HEMI® V8 – 22 MPG HWY*

PURE MUSCLE

395 HP/410 LB-FT OF TORQUE



LEGENDARY POWER TEAMS UP WITH FUEL SAVER TECHNOLOGY.

The history of the HEMI engine is one of ingenuity, innovation and uncompromising strength. By creating the distinctive hemispherical head, engineers accomplished a giant step with results that led to American dominance in transportation and revolutionary designs for industry. Applications of the “HEMI” engine design have encompassed a world of power: prototype aircraft, classic muscle cars—and Ram 1500 pickups. Impressive credentials, to be sure.

For 2015 Ram 1500, the available 5.7-liter HEMI V8 employs some of the most advanced engineering protocols ever developed. Few engines command the world-class respect duly earned by this exceptional powerhouse. Even fewer can match its efficiency and capability.

THE FUEL SAVER AT WORK: *For years we've been perfecting the Fuel Saver Technology, also known as the Multi-Displacement System (MDS), in the portfolio of HEMI engines. The technology seamlessly shuts off four of the eight cylinders when full power isn't required. During highway cruising, the mighty V8 transforms itself into a fuel-sipping four cylinder.*

VARIABLE VALVE TIMING (VVT): *VVT opens and closes the valves with utter precision; engine breathing is optimized, fuel is expended more efficiently and torque increases. Towing and hauling are a breeze.*

SHORT RUNNER VALVE (SRV): *Inside the Active Intake Manifold, the SRV controls intake airflow by changing port length based on the rpm; horsepower and torque are enhanced—giving Ram 1500 impressive capability.*

*EPA estimated 15 mpg city/22 mpg hwy based on Ram 1500 V8 4x2 with 8-speed transmission.

5.7L HEMI V8 CAPABILITY (WHEN PROPERLY EQUIPPED)



REGULAR CAB 6'4" BOX
9,180-LB MAX TOW CAPACITY
1,610-LB PAYLOAD CAPACITY



REGULAR CAB 8' BOX
10,650-LB MAX TOW CAPACITY
1,720-LB PAYLOAD CAPACITY



QUAD CAB® 6'4" BOX
10,390-LB MAX TOW CAPACITY
1,820-LB PAYLOAD CAPACITY



CREW CAB 5'7" BOX
10,370-LB MAX TOW CAPACITY
1,770-LB PAYLOAD CAPACITY



CREW CAB 6'4" BOX
10,340-LB MAX TOW CAPACITY
1,710-LB PAYLOAD CAPACITY

RAM. ECONOMY + POWER

3.0L ECODIESEL V6 – 28 MPG HWY*
ABSOLUTELY STELLAR
240 HP/420 LB-FT OF TORQUE



WE REACHED FOR THE TOP. WE MADE IT. WE'RE STILL THERE.



In one critical area—top-tier mpg ratings—we refuse to compromise. This groundbreaking powertrain—a small-displacement, high-performing turbo diesel mated to a class-exclusive^[1] 8-speed automatic transmission—vaulted Ram 1500 to the top-ranking position that delivered long-life durability, a superb driving range and best-in-class^[4] 28 mpg highway*.

This application of the available 3.0L EcoDiesel V6 with the TorqueFlite® 8-speed shows how the 2015 Ram 1500 builds on our own successes. It took the market by storm, and it takes you to the best fuel economy of ANY full-size pickup,^[4] with outstanding capability and smart ease of operation.

Ram brings you this distinctive powertrain offering with advantages that separate you from the rest of the pack: exceptional torque and superior fuel-efficient performance, welcome biodiesel (B20) capability, best-in-class^[1] 10K-mile oil change intervals and a zero-hassle DEF System.

CLEAN BY NATURE—WITH BEST-IN-CLASS^[4] 28 MPG HIGHWAY*:

Minimal CO₂ levels. Biodiesel (B20)-capable. Impressive fuel efficiency. The 6-cylinder EcoDiesel in a 2015 Ram 1500 handles it all with fluent ability.

DEFINITIVE DRIVING RANGE: *Combine the available EcoDiesel V6 with the TorqueFlite 8-speed, and you're getting the most from every tank of fuel.*

CLEAN BY DESIGN, WITH DUAL FILTRATION: *Smart from the get-go, this dual-filtration technology offers greater protection against contamination, reduces injector corrosion and enhances durability.*

ENGINEERING THAT CAN TAKE THE HEAT: *Conventional diesels use old-style metallic glow plugs. Our high-temperature ceramic glow plugs are faster-acting and withstand higher degrees for enhanced performance and lifespan.*

BUILT FOR LIFE: *Compact Graphite Iron. Oil squirters for each piston. Here, durability features go on and on; with its indomitable design, so will this engine.*

*EPA estimated 20 mpg city/28 mpg hwy based on 2014 Ram 1500 4x2 with diesel engine.

3.0L ECODIESEL V6 CAPABILITY (WHEN PROPERLY EQUIPPED)



REGULAR CAB 8' BOX
9,200-LB MAX TOW CAPACITY
1,500-LB PAYLOAD CAPACITY



QUAD CAB® 6'4" BOX
8,950-LB MAX TOW CAPACITY
1,610-LB PAYLOAD CAPACITY



CREW CAB 5'7" BOX
8,840-LB MAX TOW CAPACITY
1,540-LB PAYLOAD CAPACITY



CREW CAB 6'4" BOX
8,880-LB MAX TOW CAPACITY
1,480-LB PAYLOAD CAPACITY

FUEL



EASY RIDER

**THE BEST FUEL ECONOMY
OF ANY FULL-SIZE PICKUP^[4]**

28 MPG HWY*

WITH NO COMPROMISE TO THE CAPABILITY YOU NEED.

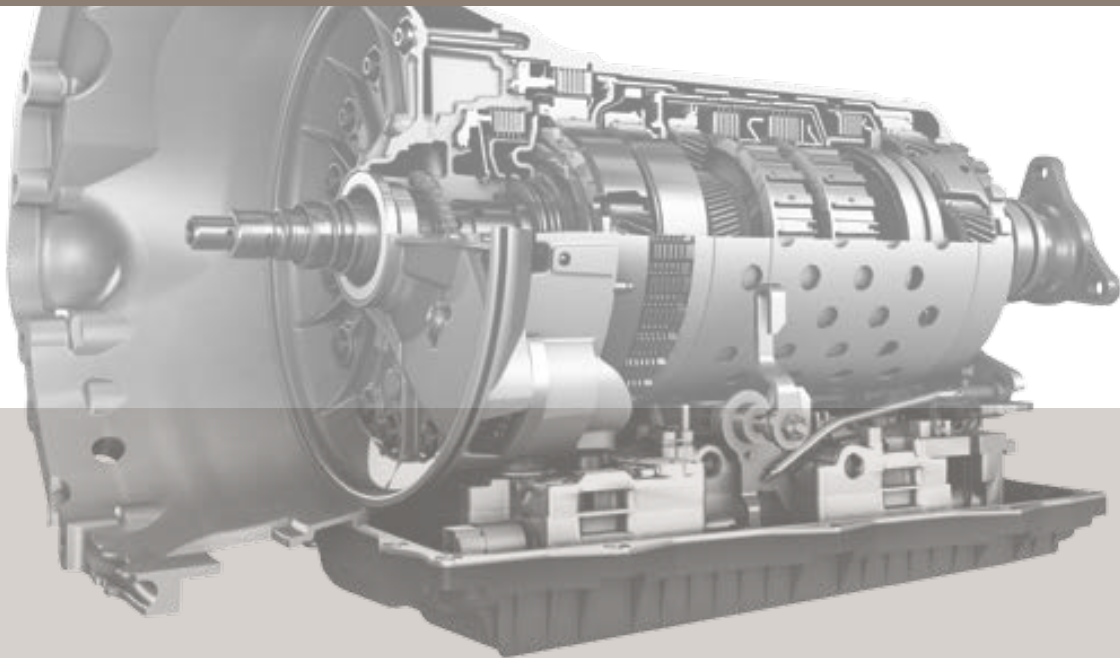

THE BENCHMARK TORQUEFLITE® 8-SPEED AUTOMATIC. AVAILABLE FOR RAM 1500 WITH ALL ENGINES.

Dual purpose by design: provide outstanding shift qualities and impeccable performance from highway cruising to heavy hauling, while making a very real contribution to the impressive Ram 1500 fuel efficiency. The groundbreaking TorqueFlite 8-speed does both.

For refined operation and driver convenience, Ram 1500 models equipped with the TorqueFlite 8-speed use steering wheel-mounted buttons when manual gear range selection is preferred, offering greater control when towing and hauling heavy loads.

*EPA estimated 20 mpg city/28 mpg hwy based on 2014 Ram 1500 4x2 with diesel engine.



QUALITY MEASURED BY

COMMAND + CONTROL



Class-exclusive⁰ Multilink Coil Spring Rear Suspension.

It's standard on every 2015 Ram 1500—and when you look into it, it's totally a premium. Unlike the competition's commonplace leaf-spring rear suspensions, the Ram 1500 class-exclusive⁰ coil spring suspension is so resilient, durable and comfortable, it's the preferred technology for freight trains. The difference is best perceived when towing: control and capability are measurably improved.

Properly secure all cargo.

STRENGTH + ADAPTABILITY

CONQUER LIFE'S UPS AND DOWNS.



Class-exclusive¹ Active-Level™ Four-Corner Air Suspension System.



This available advantage speaks for itself—and its appeal is further backed by critics who are vocal in their praise. No surprise to find it on Ram 1500. With five intelligent operating modes, our class-exclusive¹ Active-Level Four-Corner Air Suspension System gives you extra capability for off-road exploration, efficient aerodynamic performance on the highway, a level profile (even under groaning payloads), and even lowered vehicle heights for more accessible cargo loading, entry and exit. Full details on the next two pages.

A STRUCTURE BUILT ON UNCOMPROMISING INTEGRITY.

This high-strength frame is engineered with low-torsion dynamics and fully boxed side rails, strengthening the Ram 1500 reputation for minimal noise, vibration and harshness (NVH).

It's all about the towing. This structural rear bumper, rated for Class III towing, easily handles trailers up to 5,000 lb when properly equipped. For tougher trailer towing capability, opt for the available factory-installed Class IV hitch receiver, bolted directly to the frame of your Ram 1500.

Available Active Grille Shutters instantly adapt to speed, load and engine needs to provide ideal engine cooling; the shutters also significantly reduce aerodynamic drag to help improve the fuel efficiency for Ram 1500 models.

In front, the short-/long-arm suspension with coil springs and stabilizer bar minimizes camber and toe change and reduces tire wear.

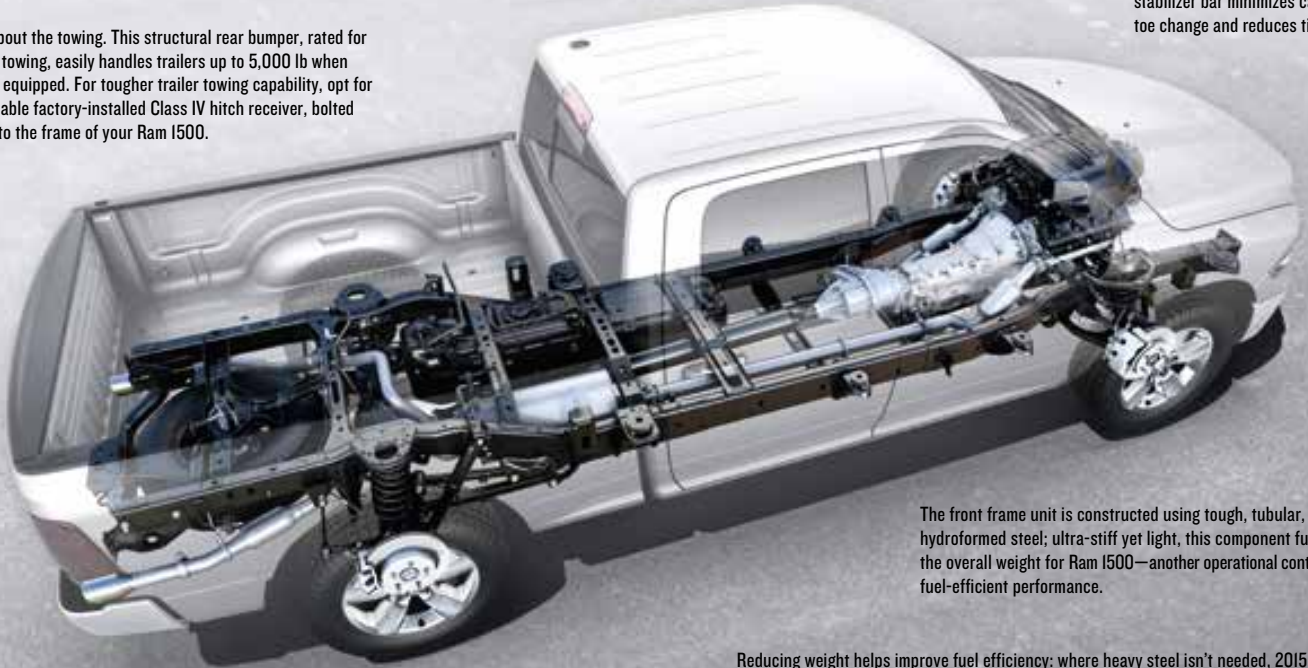

The Ram 1500 4- and 7-pin trailer tow connectors enable instant trailer electrical hookup; standard on every model.

Every Ram suspension is uniquely tuned for the best ride, handling and capability.

The front frame unit is constructed using tough, tubular, high-strength hydroformed steel; ultra-stiff yet light, this component further reduces the overall weight for Ram 1500—another operational contribution to its fuel-efficient performance.

Reducing weight helps improve fuel efficiency: where heavy steel isn't needed, 2015 Ram 1500 models employ down-gauged but stronger steel. The results give you a full-size tough pickup with weight savings that help contribute to the fuel-sipping performance.

CONTROL OF MOTION. ELECTRONIC STABILITY CONTROL (ESC)^[5] SYSTEM: HANDLING AND TOWING.

In Ram 1500, road manners, maneuverability and towing control ride hand-in-hand with safety and security. The indispensable ESC System—standard on every Ram model—provides all of it in a comprehensive package that addresses multiple dynamics that take into consideration weather, road conditions and unpredictable circumstances while towing. The Ram ESC System features these maneuverability assets:

All-Speed Traction Control regulates wheel spin. Slippage during acceleration results in throttle control to reduce torque; in extremes (e.g., when accelerating from pavement to ice), it will apply the brakes and reduce the engine power to maintain control.

Trailer Sway Damping^[5] detects yaw and applies selective brake pressure on the tow vehicle's opposite side to counteract and reduce the sway.

ESC^[5] BRAKING TO THE EXTREME.

Recent enhancements to the Ram braking system include retuning the system for optimized pedal travel, providing quicker power assist and improving the rear calipers. Rear wheel-speed ABS sensors were also repositioned for better protection against road elements. As an invaluable control system, ESC features multiple assets for braking, including vehicle control when stationary. These encompass:

Antilock Brake System (ABS). Monitoring each wheel's speed, the Ram ABS design also incorporates backup braking should one of the two braking circuits be compromised.

Electronic Brake-Force Distribution regulates brake pressure from front to rear to minimize stopping distances.

Ready Alert Braking is a system component which senses the moment when the driver's foot is lifted from the accelerator; it applies an imperceptible brake force to ensure that pads and discs are lined up should an emergency stop be required.

Rain Brake Support automatically and seamlessly activates when the driver turns on the windshield wipers; all brake calipers gently pulse against their respective rotors to remove water from the pads.

Hydraulic Boost Compensation. Should a failure occur in the vacuum brake booster or any related line (e.g., a rupture from tough off-roading), the brake controller will run the ABS pump; our system is so sophisticated, it conveys the problem to the driver. Most important, the brakes perform as normal until the failure is serviced.

Hill Start Assist. When angled on hills or inclines, this system keeps your Ram 1500 stationary for two seconds after the brakes have been released or until the accelerator is depressed.

INTELLIGENT PARKING. AVAILABLE FRONT AND REAR PARK ASSIST^[6]

The available Front and Rear Ultrasonic Park Assist System serves as a convenient aid, especially when parallel parking.

Multiple integrated sensors use ultrasonic waves to detect objects as far as 47 inches away from the bumpers, picking up the echo of a signal when it bounces off an object. Using classic echo triangulation, the system determines relative distance. Readouts located in the cluster display team up with audible chimes to notify the driver of proximity to front and/or rear objects.

A STRUCTURE BUILT ON UNCOMPROMISING INTEGRITY.

AVAILABLE ACTIVE-LEVEL™ FOUR-CORNER AIR SUSPENSION SYSTEM.

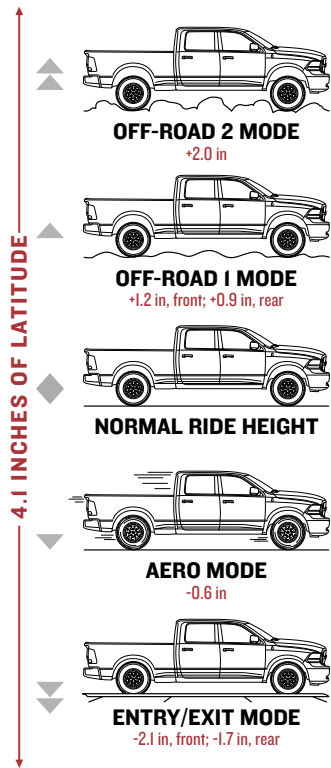

+ **OFF-ROAD 2 MODE.** Provides impressive ground clearance for the path and trail and generous angles for approach, departure and breakerover. Difference from Normal: +2.0 in.

+ **OFF-ROAD 1 MODE.** Enjoy outstanding ride balance, with an extra degree of clearance when off-road scenarios are less severe than Off-Road 2 Mode requirements. Difference from Normal: +1.2 in, front; +0.9 in, rear.

NORMAL RIDE HEIGHT. The most comfortable balance of ride and handling for everyday driving.

- **AERO MODE.** At highway speeds, the Aero Mode automatically lowers the vehicle, reducing aerodynamic drag and "body roll," and measurably improving fuel efficiency. Difference from Normal: -0.6 in.

- **ENTRY/EXIT MODE.** Automatically lowers the vehicle for easier entry/exit, loading/unloading, trailer hooking/unhooking. This mode is manually controlled by the internal button bank or remotely with the key fob. Difference from Normal: -2.1 in, front; -1.7 in, rear.

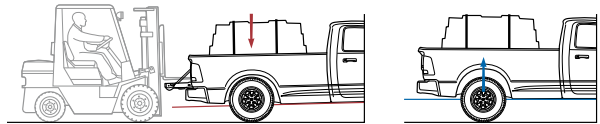

ACTIVE-LEVEL: IT JUST FLAT-OUT WORKS. Pioneered by Ram 1500, this available and class-exclusive[®] asset offers a level of sophistication that separates Ram from the rest. Or, better said, multiple levels. Augmenting the available Four-Corner Air Suspension System (with five distinct modes of operation, detailed at left), Active-Level engineering automatically equalizes your Ram 1500 while under heavy payloads. You're assured of a correct fore-and-aft vehicle balance, a constantly horizontal load plane and an even and level driving profile. Active-Level also properly maintains headlamp-to-road angle for consistent and vision-friendly forward illumination.



FINGERTIP SUSPENSION CONTROL. This integrated switch bank makes operating the available Active-Level Four-Corner Air Suspension System a snap: go from one mode to another with a push of a button for ideal ride height for your terrain and conditions. The switch bank also puts you in control of a raft of features that include the available Stop/Start System (not shown in image), the Electronic Stability Control (ESC)[®] System, the Tow/Haul Mode, along with available features like heat and ventilation for seats, the heated steering wheel and many more.

PREMIUM KEYLESS ENTER 'N GO.™ Ram fobs take advantage of the most recent developments in radio technology, and versatility and control are key. Functions range from keyless (bladeless) operation to system controls that include Remote Start, the AllSecure[®] Locking System, the panic button and even remote access of the Entry/Exit Mode of the available Active-Level Four-Corner Air Suspension System.



REPUTATIONS RIDE ON THIS. MULTILINK COIL SPRING REAR SUSPENSION.

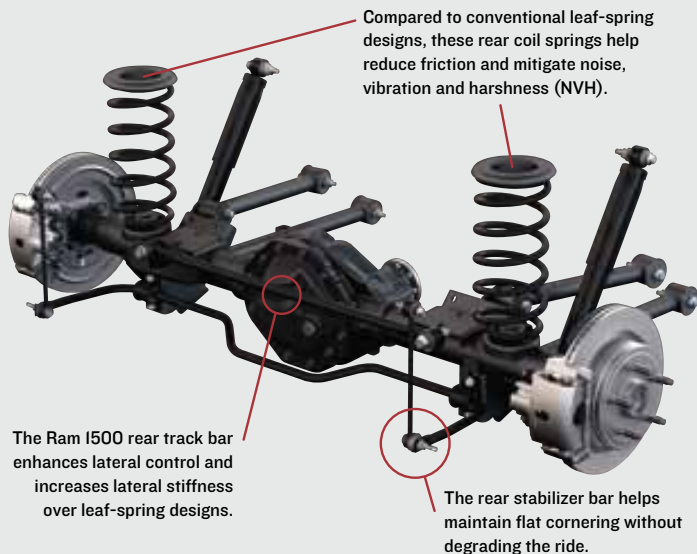

IN A CLASS OF ITS OWN, AND FAR IN FRONT. Leave the competition's leaf-spring technology where it belongs: behind you. The standard rear suspension on every 2015 Ram 1500 model is unique in the light-duty full-size pickup class, offering strength and durability that leaf springs just can't match. From the standpoint of ride comfort, the multilink coil spring rear suspension system supplies more lateral stiffness and greater vehicle control, and ramps up trailer towing for dramatically increased capability. Ride quality—the working combination of comfort and strength—is so good, coil spring technology is the preferred suspension engineering for railroad coaches and boxcars.

RAM PAYS TRIBUTE





TO THE MASTERS OF THE CRAFT.

LARAMIE LONGHORN

The 2015 Ram Laramie Longhorn. This is craftsmanship on the move, with appointments that range from premium leather-trimmed interiors and heated/ventilated seats to full-color multiview displays and European wood burl accents. The look evokes silver pocket watches or a perfectly fitted boot. With impressive choices for power, Laramie Longhorn delivers absolutely premium comfort and unimpeachable quality.





Meld beauty with functionality, and the resulting refinement is the soul of craftsmanship. Add the inner drive that compels you to pull yourself up by your own bootstraps, and you're in the best of company. Like Danner Boots, Ram shares an iconic pedigree of uncompromising quality, made manifest in the Laramie Longhorn interior (next page): stained and burled European wood accents, front bucket and rear bench seats of premium leather, here in Cattle Tan and Black, with etched leather logos and contrasting leather trim for the steering wheel, center console and door panels.

RAM. IN THE BEST OF COMPANY.

Craftsmanship: the word embodies the very spirit of our country. American craftsmanship is that rare combination of artistry, ingenuity and authentic can-do ability. It's a country tune finger-picked on an acoustic guitar carved from Sitka spruce. It's a hardwood chair hand-finished with fine-grit sandpaper and oilcloth. It's the opulent yet rustic interior of a Ram Laramie Longhorn.

Our commitment to the craft of leather started not as an audacious marketing decision, but instead with the humility that acknowledges the best. We would learn only from the masters—and few leatherworkers command the respect earned by the Danner® Boot Company.

The history of Danner boots is one of uncommonly acute business savvy and insistence on using only the finest materials. Founded in the solid American Midwest at the height of the depression, Charles Danner,

intuiting that his high-grade, durable and water-resistant boots were perfect for the logging industry, only four years later boldly moved his boot-making business to Portland, Oregon. A philosophy of zero compromise let quality prevail: today, Danner boots support soldiers, workers and hikers alike with rugged and resilient strength.

In the making of a Danner boot, more than one hundred hands cut, stitch and cobble high-grade leather into crafted footwear that stands up to time, the elements—and the competition. It's an ideal we proudly emulate.

The Ram Laramie Longhorn interior shows American craftsmanship at its peak, standing up to miles and years of use—and up to all comparison. Akin to the perfect fit of a Danner boot, Laramie Longhorn delivers quality, comfort and luxury at its best—to be enjoyed by the best.



More than one hundred hands cut, stitch and cobble high-grade leather into crafted footwear that stands up to time, the elements—and the competition.

Photographs courtesy of AmericanCraftsmanProject.com



COMFORT + ABLE



COMFORT. IN A RAM 1500, IT'S A FAMILY VALUE.

NEXT PAGE

TOP LEFT: Every Ram model offers the convenient touches that reflect practical and well-thought-out design—like easy-to-reach controls that accommodate a gloved hand, an advantage especially ideal for northern winters.

TOP RIGHT: Dash-mounted rotary dial for the 8-speed transmission, with push-button controls for the 4x4 system.

CENTER LEFT: Carefully crafted accents set Ram Laramie apart; this door panel shows off the Light Frost Beige accent against the Canyon Brown trim.

CENTER RIGHT: The center console offers use as a convenient writing surface, or for storage large enough to hold a laptop; built-in USB ports are ideal for charging and using electronic devices.

BOTTOM: A close-up of the Ram Laramie interior, showing the art of stitching with embossed Laramie logo in the leather-trimmed front seatbacks.

COMFORT BY DESIGN includes at-hand storage everywhere: dual glove boxes, in-door bins that can hold oversize beverage containers, the unique hidden in-floor bins on Ram Crew Cab, and the ultimate—the class-exclusive^[1] available RamBox[®] Cargo Management System.

While convenience ranks big, so does staying in touch. In a 2015 Ram 1500, communications, infotainment and telematics make this pickup an instant available WiFi Hotspot^{[7]*} and a hands-free/Voice Command^[8] center. It's technology that can deliver NAV-ready systems and satellite radio—speaking of which, you'll also enjoy an included year of SiriusXM[®] Satellite Radio^[9] service.

Our work is you, and it works flawlessly: we're the Ram family, and your family becomes part of us. See for yourself, and contribute your values through blogs, thoughts and owner stories at RAMTRUCKS.COM

*Additional charges apply.



LARAMIE





LARAMIE LIMITED

LUXURY + CAPABILITY



KNOWLEDGE IS POWER

Step into a Ram Pickup and you're stepping up to technology unimagined a decade ago. Each Ram model gives you state-of-the-art instrumentation and in-vehicle communications through the impressive Electronic Vehicle Information Center (EVIC). Select models feature a six-ring cluster with full-color seven-inch Thin Film Transistor (TFT) display; the customizable

multiview screen offers astonishing clarity and tons of real-time mechanical data. Add scroll-type interfaces, intuitive steering wheel-mounted toggle switches (there are 34 menu options and graphics for instant vehicle information) and PowerNet electrical architecture with "smart" modules, and you're in control of all of it.



Connectivity is key. Along with an available full-color 8.4-inch touchscreen system—the largest in the class^[1]—the brilliant universe of in-cab technology makes available a world of telematics and electronics. Uconnect can encompass a WiFi Hotspot,^[7]* Bluetooth[®] sync, hands-free Voice Command^[8] indispensable NAV systems, with an included first year of SiriusXM[®] Satellite Radio^[9] service.

UCONNECT[®] ACCESS^[10] GIVES YOU EVEN MORE.

The 2015 Ram pickups are all about keeping in touch. Next-generation Uconnect is the key. Register for the included trial^[10] of Uconnect Access^[10] services, and you've got an available on-demand WiFi Hotspot^[7]* and apps via mobile, convenient Remote Commands,^[12] Voice Texting^[13] Yelp,[®] emergency assistance and more.

- | | | | |
|-------------------------------------|---|---|-----------------------------|
| Yelp [†] | Stolen Vehicle Assistance ^[16] | Remote Horn and Lights ^[12] | iHeartRadio (via mobile) |
| 9-1-1 Call ^[14] | Theft Alarm Notification ^[17] | Remote Door Lock/Unlock ^[12] | Aha™ by Harman (via mobile) |
| Roadside Assistance ^[15] | Remote Vehicle Start ^[12] | Pandora [®] (via mobile) | Slacker Radio (via mobile) |

With SiriusXM Travel Link,^[19] get national and local weather reports, fuel prices, sports scores and more. SiriusXM Traffic^[9] gives you detailed information on traffic speed, accidents, construction, road closures and more. Your first 5 years of both services are included.**

SiriusXM
TRAFFIC
SiriusXM
TRAVEL LINK



SIRIUSXM ALL ACCESS PACKAGE. All satellite radio-equipped Ram vehicles come with a one-year trial to the SiriusXM All Access package, providing over 160 channels of the best programming for all the places life takes you.

- In your vehicle—you'll get every channel available on your radio, including all the premium programming like Howard Stern, every NFL[®] game, every MLB[®] game, every NASCAR[®] race, Oprah Radio and more.
- On the go—with a SiriusXM Internet Radio subscription included with the All Access trial, you'll get SiriusXM on your computer, smartphone or tablet. Go to siriusxm.com/getallaccess for more information.

*Additional charges apply. [†]Uconnect 8.4A: 6-month trial. Uconnect 8.4AN: 12-month trial. [‡]Certain features are not available while vehicle is in motion. ^{**}Available on select Uconnect systems. See dealer for details.



BEAST OF BURDEN



Properly secure all cargo.



+ RECREATION

Class-exclusive:⁽¹⁾ **RamBox[®]**
Cargo Management System.



For total versatility in storage and cargo-carrying, we're available. Ram 1500 is the only pickup in its class⁽¹⁾ to offer the available RamBox Cargo Management System. You'll see: from work to leisure, it makes a world of difference.

Properly secure all cargo.

WHEN YOU'RE ON THE MOVE, RAM GIVES YOU ROOM TO SPARE.

THE SCENARIOS DEMANDED OF A RAM I500 range from hauling boulders from quarries, to moving weekly half-ton loads of animal feed, to transporting the industrial machinery that keeps America running. With impressive frames and chassis working with exceptional suspensions, a Ram 1500 pickup is ready to deliver incredible hauling and towing at a moment's notice. From helping a pal to earning a paycheck, this is capability that's ready and willing to work.

Ram 1500 matches tough-truck strength with design refinements that make interior stashing and storage no work at all. Select models provide an available rear fold-flat load floor, enabling hauling ability for items best kept inside. Front-center seats open for valuable at-hand storage—and fold flat when you need a level surface for writing or connecting with your laptop. Huge in-door bins offer serious volume and easy access, while the in-floor storage bins on Crew Cab set the benchmark for keeping valuables out of sight.

For outstanding hauling and storage measured by both capacity and convenience, this is the truck: the 2015 Ram 1500.

NEXT PAGE

TOP: Dual glove boxes ramp up storage capacity; the Ram 1500 extra-large in-door bins were designed to hold oversize bottles, with ample adjacent space for large items.

MIDDLE: In-floor storage bins of Ram Crew Cab models are more than convenient—they're removable; our seats offer triple capacity: the front-row center can be a third seat, a fold-flat writing or working surface, or a spacious storage compartment with convenient cup holders.

BOTTOM: Under-the-seat storage spaces are ideal when you want to stash items best left out of sight; the available fold-flat load floors on Ram Quad Cab® and Crew Cab models are welcome real estate for tools or fragile cargo.

THIS PAGE

BELOW: No other competitor offers it: the class-exclusive^[1] available RamBox® Cargo Management System enlarges cargo-carrying with cavernous side boxes, a bed extender/divider, cargo rails and tie-down cleats.

REMOTE KEYLESS ENTRY WITH ALLSECURE® LOCKING SYSTEM.

Versatile key fobs are ideal when entering Ram 1500 with arms full: the optional AllSecure Locking System locks/unlocks all doors, the tailgate and (if equipped) both RamBox System bins. Functions can include Remote Start, panic button and even the Entry/Exit Mode of the available Active-Level™ Four-Corner Air Suspension System.



PREMIUM KEYLESS ENTER 'N GO™

CLASS-EXCLUSIVE.^[1] AVAILABLE RAMBOX CARGO MANAGEMENT SYSTEM.

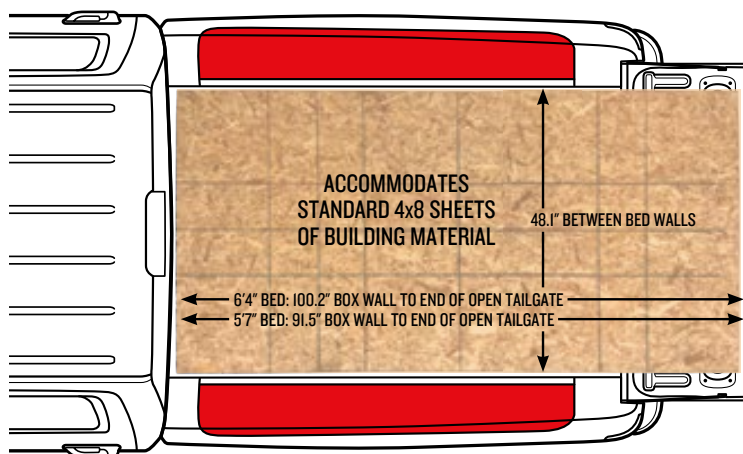
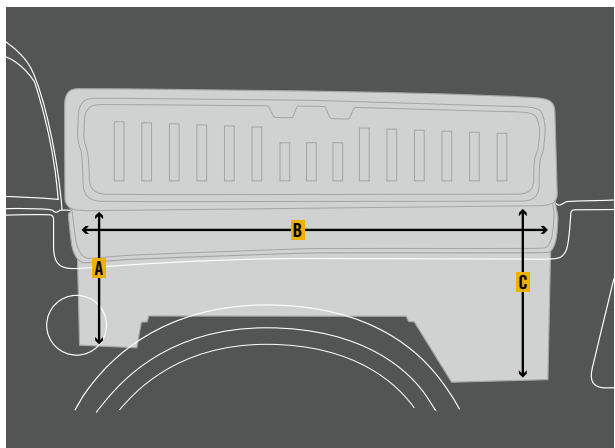

RAMBOX SYSTEM BIN SIZES	5'7" CARGO BED	6'4" CARGO BED
Height at A	14.4 inches	18.6 inches
Length at B	51.6 inches	60.2 inches
Height at C	18.9 inches	18.9 inches
TOTAL VOLUME (both bins)	7.3 cubic feet	8.6 cubic feet

It's a vexing problem the competition still hasn't solved: how do you easily and securely haul and store a variety of items for work, play and the great outdoors—while retaining the capability to handle standard 4x8 sheets of building materials? Select Ram 1500 models with 5'7" and 6'4" beds provide a class-exclusive^[1] solution: the available RamBox Cargo Management System.

This ingenious engineering simplifies virtually every hauling need, providing a lightweight bed extender/divider (stored at the front of the bed when not in use), cargo side rails and four adjustable tie-down cleats. With control by the Remote Key Fob, the two large illuminated, drainable and lockable RamBox System bins are so versatile, there are even Authentic Accessories from Mopar® created for the sportsman that fit inside. Check it out at MOPAR.COM

Properly secure all cargo.





RAM TAKES YOU OFF THE BEATEN PATH.



LET'S KEEP IT AUTHENTIC.



Ram 1500 Regular Cab Express in Flame Red shown with available Mopar® Sport Performance Hood, Roll-Up Tonneau Cover, Black Tubular Side Steps and 20-inch Black Aluminum Wheels.

MOPAR. SUPPORTING YOU AND YOUR RAM TRUCK—FOR THE LONG HAUL.

Make your new Ram truck the ideal ride—for today, and for years to come.

The Authentic Ram Parts and Accessories by Mopar are engineered by the same experts who designed your Ram truck, ensuring perfect fit, function and finish. You'll benefit from trained technicians who know your make and model best and use genuine parts to keep your Ram truck going strong.

Today, Mopar provides more than just Authentic Accessories for your Ram truck. Our all-inclusive advantages encompass: Mopar Express Lane Service to minimize waiting and downtime, Mopar Vehicle Protection® Plans—the only extended protection backed by the manufacturer and our state-of-the-art Mopar Owner Connect Web site that provides online access to your service records, vehicle information and exclusive money-saving offers that give you the best from Mopar—for less. In every way, Mopar support is all about keeping you happy, and your Ram truck at its best. For more, visit us at MOPAR.COM



Sport/Performance Hood with Decal



Tri-Fold Tonneau Cover



Tubular Side Steps

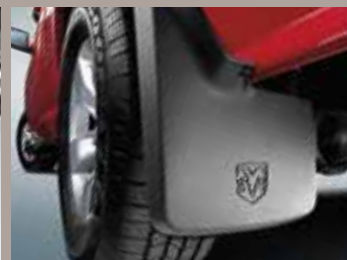

Molded Splash Guards

1500 WHEELS



17-inch Argent Steel
Standard on Tradesman (WFP)



17-inch Painted Aluminum
Standard on SLT, Outdoorsman and HFE
Optional on Tradesman (WFE)



17-inch Chrome-Clad Aluminum
Optional on Big Horn/Lone Star* and Laramie (WFJ)



20-inch Painted Aluminum
Standard on Express
Optional on Outdoorsman (WHE)



20-inch Chrome-Clad Aluminum
Optional on Express (WR2)



20-inch Chrome-Clad Aluminum
Standard on Big Horn/Lone Star* (WHK)



20-inch Polished Aluminum
with Painted Pockets
Standard on Sport (WRF)



20-inch Chrome-Clad Aluminum
Standard on Laramie (WRG)



20-inch Aluminum with Polished Face
and White Gold-Clad Inserts
Standard on Two-Tone Laramie Longhorn (WRH)



20-inch Aluminum with Polished Face
and Painted Inserts
Standard on Laramie Longhorn with Monotone Paint (WRJ)



20-inch Aluminum Painted Satin Carbon
with Chrome Inserts
Standard on Laramie Limited (WRM)



20-inch Polished Aluminum
Optional on Laramie Longhorn and Laramie Limited (WRT)



20-inch Semi-Gloss Black
Painted Aluminum
Optional on Express and Outdoorsman (WHN)



22-inch Polished Forged Aluminum
Standard on Regular Cab R/T
Optional on Crew Cab Sport (WPZ)

1500 TRIM LEVELS

Tradesman
Ready-to-work attitude with every economy you need



Express
Pure capability with functional interiors



CABS	BEDS	SEATING
Regular Cab	6'4" Box or 8' Box	40/20/40 Bench Seat
Quad Cab*	6'4" Box	40/20/40 Bench Seat
Crew Cab	5'7" Box or 6'4" Box	40/20/40 Bench Seat



Available Black Express Group shown

CABS	BEDS	SEATING
Regular Cab	6'4" Box	40/20/40 Bench Seat
Quad Cab	6'4" Box	40/20/40 Bench Seat
Crew Cab	5'7" Box	40/20/40 Bench Seat

MECHANICAL

3.6L Pentastar® V6 with 8-speed automatic transmission
• Active Grille Shutters • Electronic Stability Control (ESC)^[6]
System includes 4-wheel ABS, Brake Assist, Rain Brake Support, Ready Alert Braking, All-Speed Traction Control, Electronic Roll Mitigation, Hill Start Assist and Trailer Sway Damping^[6] • Multilink coil spring rear suspension • 26-gallon fuel tank (32-gallon fuel tank with 8-foot-box models) • Electronic part-time transfer case on 4x4 models

INTERIOR

Vinyl 40/20/40 front bench seat • Vinyl folding rear bench seat on Quad Cab and Crew Cab models • Vinyl floor covering • Advanced multistage front air bags^[6] • Supplemental side-curtain air bags^[6] • Supplemental front-seat side-mounted air bags^[6] • Tilt steering wheel • Automatic headlamps • Air conditioning • Power windows and power door locks on Quad Cab and Crew Cab models • 3.5-inch LCD Electronic Vehicle Information Center (EVIC) in the instrument cluster • Uconnect® 3.0 AM/FM system • MP3 auxiliary jack and 1.5-amp USB port

EXTERIOR

Black front and rear bumpers • Black grille surround and inserts • Black front upper fascia • Quad-lens headlamps • Bed rail caps • Spray-in bedliner • Locking tailgate • 4- and 7-pin trailer wiring harness/connectors • Class IV trailer hitch receiver • 17-inch painted steel wheels with BSW tires • Black fold-in sideview mirrors

MECHANICAL

3.6L Pentastar V6 with 8-speed automatic transmission
• Active Grille Shutters • ESC^[6] System • Multilink coil spring rear suspension • 26-gallon fuel tank • Electronic part-time transfer case on 4x4 models

INTERIOR

Vinyl 40/20/40 front bench seat • Vinyl folding rear bench seat on Quad Cab and Crew Cab models • Carpet floor covering • Advanced multistage front air bags^[6] • Supplemental side-curtain air bags^[6] • Supplemental front-seat side-mounted air bags^[6] • Tilt steering wheel • Automatic headlamps • Air conditioning • Power windows and power door locks on Quad Cab and Crew Cab models • 3.5-inch LCD EVIC in the instrument cluster • Uconnect 3.0 AM/FM system • MP3 auxiliary jack and 1.5-amp USB port

EXTERIOR

Body-color full front fascia and rear bumper • Fog lamps • Body-color grille surround with Black inserts • Quad-lens headlamps • Bed rail caps • Locking tailgate • 4- and 7-pin trailer wiring harness/connectors • 20-inch painted aluminum wheels with BSW tires • Black fold-in sideview mirrors

*Lone Star model only available in Texas.

1500 TRIM LEVELS

HFE

Its very name spells out High Fuel Efficiency

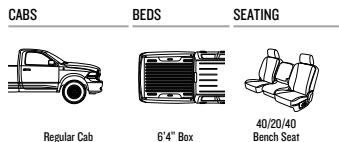

MECHANICAL

3.6L Pentastar® V6 with 8-speed automatic transmission • Active Grille Shutters • Stop/Start technology • 220-amp alternator • 800-amp battery • Remote keyless entry • Electronic Stability Control (ESC)^[6] System • Multilink coil spring rear suspension • 26-gallon fuel tank

INTERIOR

Cloth 40/20/40 front bench seat • Carpet floor covering • Advanced multistage front air bags^[6] • Supplemental side-curtain air bags^[6] • Supplemental front-seat side-mounted air bags^[6] • Tilt steering wheel • Automatic headlamps • Air conditioning • 3.5-inch LCD Electronic Vehicle Information Center (EVIC) in the instrument cluster • Uconnect® 3.0 AM/FM system • MP3 auxiliary jack and USB port

EXTERIOR

Black front and rear bumpers • Black grille surround with Black inserts • Black front upper fascia • Quad-lens headlamps • Black door handles • Bed rail caps • Locking tailgate • Tri-folding cargo bed tonneau cover • 4- and 7-pin trailer wiring harness/connectors • 17-inch painted aluminum wheels with BSW tires • Black, manual, fold-in sideview mirrors

SLT

Totally affordable, with an upscale exterior

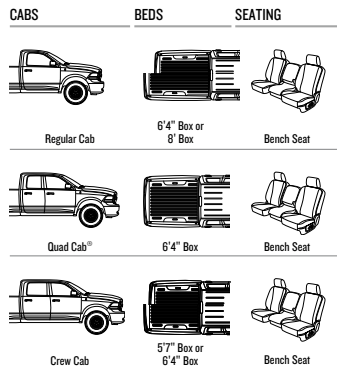

MECHANICAL

3.6L Pentastar V6 with 8-speed automatic transmission • Active Grille Shutters • Remote keyless entry • ESC^[6] System • Multilink coil spring rear suspension • 26-gallon fuel tank (32-gallon fuel tank with 8-foot-box models) • Electronic part-time transfer case on 4x4 models

INTERIOR

Cloth 40/20/40 front bench seat • Cloth folding rear bench seat on Quad Cab and Crew Cab models • Carpet floor covering • Advanced multistage front air bags^[6] • Supplemental side-curtain air bags^[6] • Supplemental front-seat side-mounted air bags^[6] • Tilt steering wheel • Automatic headlamps • Air conditioning • Power windows and power door locks • 3.5-inch LCD EVIC in the instrument cluster • Uconnect 5.0 AM/FM/Bluetooth® touchscreen system with SiriusXM® Satellite Radio^[9] • MP3 auxiliary jack and 2.5-amp USB port • Overhead console • Power sliding rear window on Quad Cab and Crew Cab models

EXTERIOR

Chrome front and rear bumpers • Chrome grille surround with Black inserts • Body-color front upper fascia • Quad-lens headlamps • Chrome door handles • Bed rail caps • Locking tailgate • 4- and 7-pin trailer wiring harness/connectors • 17-inch painted aluminum wheels with BSW tires • Black, power, heated, fold-in sideview mirrors

Big Horn/Lone Star*

Richly appointed—and even a brand for Texas

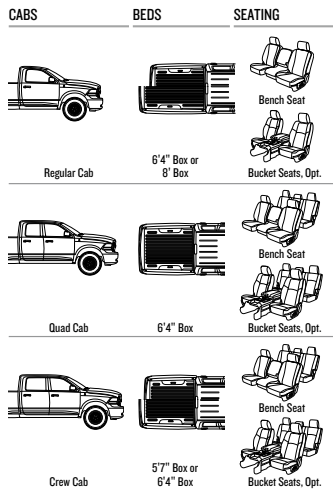

MECHANICAL

3.6L Pentastar V6 with 8-speed automatic transmission • Remote keyless entry • ESC^[6] System • Multilink coil spring rear suspension • 26-gallon fuel tank • Electronic on-demand transfer case on 4x4 models

INTERIOR

Premium cloth 40/20/40 front bench seat with power driver's side • Cloth 60/40 split-folding rear bench seat • Carpet floor covering • 115-volt power outlet • Advanced multistage front air bags^[6] • Supplemental side-curtain air bags^[6] • Supplemental front-seat side-mounted air bags^[6] • Leather-wrapped tilt steering wheel with audio controls • Automatic headlamps • Air conditioning • Power windows and power door locks • 3.5-inch LCD EVIC in the instrument cluster • Uconnect 5.0 AM/FM/Bluetooth touchscreen system with SiriusXM Satellite Radio^[9] • MP3 auxiliary jack and 2.5-amp USB port • Overhead console • Power sliding rear window

EXTERIOR

Chrome front and rear bumpers • Fog lamps • Chrome grille surround with chrome billet inserts • Body-color front upper fascia • Quad-lens headlamps • Chrome door handles • Bed rail caps • Locking tailgate • 4- and 7-pin trailer wiring harness/connectors • Class IV trailer hitch receiver • 20-inch chrome-clad aluminum wheels with BSW tires • Black, power, heated, fold-in sideview mirrors

Outdoorsman

Outfitted for the great outdoors



Shown with standard Black lower



Available Monotone paint shown

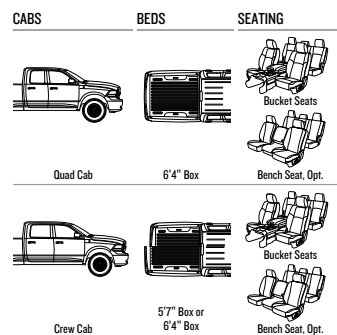

MECHANICAL

3.6L Pentastar V6 with 8-speed automatic transmission • Remote keyless entry • ESC^[6] System • Multilink coil spring rear suspension • 32-gallon fuel tank • Tow hooks • Limited-slip differential and skid plates for the transfer case and front suspension on 4x4 models • Remote Start and Security Group • Electronic part-time transfer case on 4x4 models

INTERIOR

Premium cloth front bucket seats • Power driver's seat • Full-floor center console • 115-volt power outlet • Cloth 60/40 split-folding rear bench seat • Carpet floor covering • Rubber all-weather floor mats • Luxury Group • Advanced multistage front air bags^[6] • Supplemental side-curtain air bags^[6] • Supplemental front-seat side-mounted air bags^[6] • Leather-wrapped tilt steering wheel with audio controls • Automatic headlamps • Air conditioning • Power windows and power door locks • 7-inch Thin Film Transistor (TFT) premium programmable multiview display EVIC in the instrument cluster • Uconnect 8.4A AM/FM/Bluetooth/Access^[10] touchscreen system with SiriusXM Satellite Radio^[9] • MP3 auxiliary jack, 2.5-amp USB port and SD card slot • Overhead console with Universal Garage Door Opener • Power sliding rear window

EXTERIOR

Two-tone paint with lower body, front bumper, rear bumper and fender flares in Black • Fog lamps • Body-color grille surround with Black inserts • Body-color front upper fascia • Quad-lens headlamps • Black door handles • Bed rail caps • Locking tailgate • 4- and 7-pin trailer wiring harness/connectors • Class IV trailer hitch receiver • 17-inch painted aluminum wheels with LT All-Terrain tires • Black power-heated/power-folding sideview mirrors with puddle lamps and turn signal indicators









*Lone Star model only available in Texas.

1500 TRIM LEVELS

Sport

Head-turning good looks—with attitude to match



CABS	BEDS	SEATING
 Regular Cab	 6'4" Box	 Bucket Seats
 Quad Cab [®]	 6'4" Box	 Bucket Seats
 Crew Cab	 5'7" Box or 6'4" Box	 Bucket Seats

MECHANICAL

5.7L HEMI[®] V8 with 8-speed automatic transmission • 3.92 axle ratio (R/T model) • Remote keyless entry • Electronic Stability Control (ESC)^[5] System • ParkView[®] Rear Back-Up Camera^[6] • Multilink coil spring rear suspension • 26-gallon fuel tank • Electronic on-demand transfer case on 4x4 models

INTERIOR

Premium cloth heated front bucket seats • Power driver's seat • Full-floor center console • 115-volt power outlet • Cloth 60/40 split-folding rear bench seat on Quad Cab and Crew Cab models • Carpet floor covering • Luxury Group • Advanced multistage front air bags^[6] • Supplemental side-curtain air bags^[6] • Supplemental front-seat side-mounted air bags^[6] • Heated leather-wrapped tilt steering wheel with audio controls • Automatic headlamps • Automatic Temperature Control (ATC) • Power windows and power door locks • 7-inch Thin Film Transistor (TFT) premium programmable multiview display Electronic Vehicle Information Center (EVIC) in the instrument cluster • Uconnect[®] 8.4A AM/FM/Bluetooth/Access^[10] touchscreen system with SiriusXM[®] Satellite Radio^[9] • MP3 auxiliary jack, 2.5-amp USB port and SD card slot • Overhead console with Universal Garage Door Opener • Power sliding rear window on Quad Cab and Crew Cab models

EXTERIOR

Monochromatic paint with body-color full-front fascia and rear bumper • Fog lamps • Body-color grille surround with chrome billet inserts • Premium Sport projector headlamps with LED turn signal/running lights • Body-color door handles • Bed rail caps • Locking tailgate • Premium LED Sport taillamps • 4- and 7-pin trailer wiring harness/connectors • 20-inch polished-face aluminum wheels with OWL tires • Body-color power-heated/power-folding sideview mirrors with puddle lamps and turn signal indicators • 4-inch chrome-tipped dual exhaust • R/T model-specific features (Regular Cab only): • 22-inch polished forged aluminum wheels with BSW tires • Sport performance hood • Black hex grille inserts with R/T emblem

Laramie









Where luxury and leather trim come together



Shown with standard Silver lower



Available Monotone paint shown

CABS	BEDS	SEATING
 Quad Cab	 6'4" Box	 Bench Seat  Bucket Seats, Opt.
 Crew Cab	 5'7" Box or 6'4" Box	 Bench Seat  Bucket Seats, Opt.

MECHANICAL

3.6L Pentastar[®] V6 with 8-speed automatic transmission • Remote keyless entry • Security Alarm System • ESC^[5] System • ParkView Rear Back-Up Camera^[6] • Multilink coil spring rear suspension • 26-gallon fuel tank • Electronic on-demand transfer case on 4x4 models

INTERIOR

Leather-trimmed 40/20/40 front bench seat • Power driver's and front-passenger seats • Heated and ventilated front seats • 115-volt power outlet • Leather-trimmed 60/40 split-folding rear bench seat • Carpet floor covering • Advanced multistage front air bags^[6] • Supplemental side-curtain air bags^[6] • Supplemental front-seat side-mounted air bags^[6] • Heated leather-wrapped tilt steering wheel with audio controls • Automatic headlamps • ATC • Power windows and power door locks • 7-inch TFT premium programmable multiview display EVIC in the instrument cluster • Uconnect 8.4A AM/FM/Bluetooth/Access^[10] touchscreen system with SiriusXM Satellite Radio^[9] • MP3 auxiliary jack, 2.5-amp USB port and SD card slot • Premium 10-speaker Surround Sound Audio System • Overhead console with Universal Garage Door Opener • Power adjustable pedals with memory • Power sliding rear window

EXTERIOR

Two-tone paint with lower body and fender flares in Bright Silver Metallic • Chrome front and rear bumpers • Fog lamps • Chrome grille surround with chrome wave perforated inserts • Premium projector headlamps with LED turn signal/running lights • Chrome door handles • Bed rail caps • Locking tailgate • Premium LED taillamps • 4- and 7-pin trailer wiring harness/connectors • 20-inch chrome-clad aluminum wheels with BSW tires • Chrome power-heated/power-folding sideview mirrors with puddle lamps and turn signal indicators

Laramie Longhorn



Sophistication meets power and comfort



Shown with standard White Gold Metallic lower



Available Monotone paint shown

CABS	BEDS	SEATING
 Crew Cab	 5'7" Box or 6'4" Box	 Bucket Seats

MECHANICAL

5.7L HEMI V8 with 8-speed automatic transmission • Remote keyless entry • Security Alarm System • Remote start • ESC^[5] System • ParkSense[®] Front and Rear Park Assist^[6] • ParkView Rear Back-Up Camera^[6] • Multilink coil spring rear suspension • 32-gallon fuel tank • Electronic on-demand transfer case on 4x4 models

INTERIOR

Premium leather front bucket seats • Power driver's and front-passenger seats • Heated and ventilated front seats • Full-floor center console with leather cover • 115-volt power outlet • Premium leather heated 60/40 split-folding rear bench seat • Carpet floor covering • Premium floor mats with removable inserts • Advanced multistage front air bags^[6] • Supplemental side-curtain air bags^[6] • Supplemental front-seat side-mounted air bags^[6] • Heated leather-wrapped tilt steering wheel with wood accent and audio controls • Automatic headlamps • ATC • Power windows and power door locks • Ultra-premium instrument cluster with 7-inch TFT premium programmable multiview display EVIC in the instrument cluster • Uconnect 8.4AN AM/FM/Bluetooth/Access^[10]/NAV touchscreen system with SiriusXM Satellite Radio^[9] SiriusXM Traffic^[9] and SiriusXM Travel Link^[9] • MP3 auxiliary jack, 2.5-amp USB port and SD card slot • Premium 10-speaker Surround Sound Audio System • Overhead console with Universal Garage Door Opener • Power adjustable pedals with memory • Power sliding rear window • LED additional interior lighting

EXTERIOR

Two-tone paint with lower body, fender flares, front bumper, rear bumper and running boards in White Gold Metallic • Fog lamps • Chrome grille surround with chrome wave mesh inserts • Unique Laramie Longhorn badging • Premium projector headlamps with LED turn signal/running lights • Chrome door handles • Bed rail caps • Spray-in bedliner • Locking tailgate • Premium LED taillamps • 4- and 7-pin trailer wiring harness/connectors • 20-inch polished aluminum wheels with White Gold-clad inserts and BSW tires • Chrome power-heated/power-folding sideview mirrors with puddle lamps and turn signal indicators • 4-inch chrome-tipped dual exhaust



Laramie Limited

All-Black leather treatment joins stunning technology



Available Limited Appearance Group shown



CABS	BEDS	SEATING
 Crew Cab	 5'7" Box or 6'4" Box	 Bucket Seats

MECHANICAL

5.7L HEMI V8 with 8-speed automatic transmission • Remote keyless entry • Security Alarm System • Remote start • ESC^[5] System • ParkSense[®] Front and Rear Park Assist^[6] • ParkView Rear Back-Up Camera^[6] • Active-Level™ Four-Corner Air Suspension System • 32-gallon fuel tank • Electronic on-demand transfer case on 4x4 models

INTERIOR

Premium Black Natura Plus leather front bucket seats • Power driver's and front-passenger seats • Heated and ventilated front seats • Full-floor center console with leather cover • 115-volt power outlet • Premium Black Natura Plus leather heated 60/40 split-folding rear bench seat • Carpet floor covering • Premium floor mats with removable inserts • Advanced multistage front air bags^[6] • Supplemental side-curtain air bags^[6] • Supplemental front-seat side-mounted air bags^[6] • Heated leather-wrapped tilt steering wheel with wood accent and audio controls • Automatic headlamps • ATC • Power windows and power door locks • Ultra-premium instrument cluster with 7-inch TFT premium programmable multiview display EVIC in the instrument cluster • Uconnect 8.4AN AM/FM/Bluetooth/Access^[10]/NAV touchscreen system with SiriusXM Satellite Radio^[9] SiriusXM Traffic^[9] and SiriusXM Travel Link^[9] • MP3 auxiliary jack, 2.5-amp USB port and SD card slot • Premium 10-speaker Surround Sound Audio System • Overhead console with Universal Garage Door Opener • Power adjustable pedals with memory • Power sliding rear window • LED additional interior lighting

EXTERIOR

Monotone paint • Fog lamps • Chrome grille surround with chrome wave mesh inserts • Unique Laramie Limited badging • Premium projector headlamps with LED turn signal/running lights • Chrome door handles • Bed rail caps • Spray-in bedliner • Locking tailgate • Premium LED taillamps • 4- and 7-pin trailer wiring harness/connectors • 20-inch painted aluminum wheels with chrome inserts and BSW tires • Chrome power-heated/power-folding sideview mirrors with puddle lamps and turn signal indicators • 4-inch chrome-tipped dual exhaust • Stainless steel wheel-to-wheel tubular side steps

1500 EXTERIOR COLORS



Black



Black Forest Green Pearl



Bright White



Bright Silver Metallic



Blue Streak Pearl



Deep Cherry Red Crystal Pearl



Flame Red



Maximum Steel Metallic



Granite Crystal Metallic



Prairie Pearl



True Blue Pearl



Western Brown Pearl

1500 INTERIOR FABRICS



Vinyl
Diesel Gray
Tradesman and Express



Sedoso/Embossed Cloth
Diesel Gray
Tradesman, Express, SLT and HFE



Sedoso/Embossed Cloth
Canyon Brown
SLT



Sedoso/Carbide Cloth
Diesel Gray
Big Horn/Lone Star* and Outdoorsman



Sedoso/Carbide Cloth
Canyon Brown
Big Horn/Lone Star* and Outdoorsman



Bristol Vinyl/Sport Mesh Cloth
Black
Sport



Bristol Leather/Perforated Leather Trim
Light Frost Beige
Laramie



Bristol Leather/Perforated Leather Trim
Black
Sport and Laramie



Natura Leather/Perforated Leather with Black Piping and Black Accent Stitching
Cattle Tan
Laramie Longhorn



Natura Leather/Perforated Leather with Dark Saddle Piping and Tan Accent Stitching
Canyon Brown
Laramie Longhorn



Natura Leather with Laser Etching/Perforated Leather with Dark Saddle Piping and Tan Accent Stitching
Canyon Brown
Laramie Longhorn



Natura Leather/Perforated Leather with Medium Gray Stone Piping and Medium Gray Stone Accent Stitching
Black
Laramie Limited

*Lone Star model only available in Texas.

1500 BUYER'S GUIDE

	TRADSMAN REG/QUAD/CREW	EXPRESS REG/QUAD/CREW	HFE REG	SLT REG/QUAD/CREW	BIGHORN/ONE STAR REG/QUAD/CREW	OUTDOORSMAN QUAD/CREW	SPORT REG/QUAD/CREW	LARAME QUAD/CREW	LARAME LONGHORN CREW	LARAME LIMITED CREW
CPOS PACKAGE										
INTERIOR FEATURES (continued)										
— Premium cloth-trimmed 40/20/40 split-bench front seat, front armrest with cup holder, power 10-way driver's seat, power lumbar adjuster, front center-seat cushion storage, 115-volt auxiliary power outlet (Quad Cab [®] and Crew Cab models include 60/40 split-folding rear bench seat with underseat storage and fold-flat load floor storage) (*M9)					S	0				
— Premium cloth-trimmed low-back bucket seats, power 10-way driver's seat, power lumbar adjuster, full-length floor console, 115-volt auxiliary power outlet (Quad Cab and Crew Cab models include 60/40 split-folding rear bench seat trimmed in cloth with underseat storage and fold-flat load floor storage) (*Mj)					0	S				
— Premium cloth/vinyl-trimmed high-back heated bucket seats, power 10-way driver's seat, power lumbar adjuster, full-length floor console, 115-volt auxiliary power outlet (Quad Cab and Crew Cab models include 60/40 split-folding rear bench seat trimmed in cloth/vinyl with underseat storage and fold-flat load floor storage) (*Aj)							S			
— Leather-trimmed high-back, ventilated and heated bucket seats, includes power 10-way driver and power 6-way passenger, power lumbar adjuster, full-length floor console, 115-volt auxiliary power outlet (Quad Cab and Crew Cab models include 60/40 split-folding rear bench seat trimmed in vinyl with underseat storage and fold-flat load floor storage; not available on Regular Cab) (*G)							0			
— Leather-trimmed 40/20/40 split-bench heated and ventilated front with power 10-way/memory for driver and power 6-way passenger, power lumbar adjuster, front center-seat cushion storage and folding center armrest with cup holder, 115-volt auxiliary power outlet (Quad Cab and Crew Cab models include 60/40 split-folding rear bench seat trimmed in vinyl with underseat storage and fold-flat load floor storage) (*VL)								S		
— Leather-trimmed high-back, ventilated and heated bucket seats, includes power 10-way driver and power 6-way passenger, power lumbar adjuster, full-length floor console, 115-volt auxiliary power outlet and heated 2nd-row on Crew Cab models (Quad Cab and Crew Cab models include 60/40 split-folding rear bench seat trimmed in vinyl with underseat storage and fold-flat load floor storage) (*G)								0		
— Premium leather with laser-etched design, high-back ventilated and heated bucket seats, includes power 10-way driver and power 6-way passenger, power lumbar adjuster, premium full-length floor console, 115-volt auxiliary power outlet, heated 2nd-row seats; includes 60/40 split-folding premium leather rear bench seat with underseat storage (available only in Canyon Brown) (*Xj)									S	
— Premium leather high-back, ventilated and heated bucket seats, includes power 10-way driver and power 6-way passenger, power lumbar adjuster, premium full-length floor console, 115-volt auxiliary power outlet, heated 2nd-row seats; includes 60/40 split-folding premium leather rear bench seat with underseat storage and fold-flat load floor storage (available in Canyon Brown or Cattle Tan) (*Dj)										0
— Premium Natura leather high-back, ventilated and heated bucket seats, includes power 10-way driver and power 6-way passenger, power lumbar adjuster, premium full-length floor console, 115-volt auxiliary power outlet, heated 2nd-row seats; includes 60/40 split-folding premium leather rear bench seat with underseat storage and fold-flat load floor storage (available only in Black) (*UL)										S
STEERING WHEEL — Urethane	S	S	S	S						
— Leather-wrapped with audio control buttons (included with Luxury Group)					S	S	S	S		
— Leather-wrapped, genuine wood, heated, with audio control buttons									S	S
— Heated (included with Comfort Group)					P	P	S	S	S	S
STORAGE — Front-seat center cushion (included with *M9 and *VL seats)						S	P			
— Front, behind the seats (Regular Cab only)	S	S	S	S	S	S	S	S	S	S
— Rear, in-floor bins, two with removable liners (Crew Cab only)	S	S		S	S	S	S	S	S	S
— Rear, underseat compartment (Quad Cab and Crew Cab models only)	S	S		S	S	S	S	S	S	S
— Dual glove boxes with closing doors				S	S	S	S	S	S	S
SUNROOF — Power (Quad Cab and Crew Cab models only)				0	0	0	0	0	0	0
WINDOWS — Manual (Regular Cab only)	S	S	S							
— Power, front with driver's one-touch down (Regular Cab only; included with Power and Remote Entry Group)	P	P		S	S	S				
— Power, front and rear with driver's one-touch down-and-up (Quad Cab and Crew Cab models only)	S	S		S	S	S	S	S	S	S
— Rear backlight, fixed (standard on Regular Cab models)	S	S	S	S	S	S				
— Rear backlight, sliding (Regular Cab only)	0	0		0	0		0			
— Rear backlight, power sliding (Quad Cab and Crew Cab models only)				S	S	S	S	S	S	S
— Rear defroster (with fixed glass or power sliding rear backlight only)				0	0	0	0	0	0	0
UCONNECT[®]										
CONNECTIVITY — Auxiliary input jack for mobile devices	S	S	S	S	S	S	S	S	S	S
— USB 1.5-amp fully functioning port	S	S	S	S	S	S	S	S	S	S
— USB 2.5-amp charging-only port (included with *V9, *M9, *MJ seats and Uconnect 5.0 system)	P	P	P	S	S	S	S	S	S	S
— SD card (included with Uconnect 8.4A and 8.4AN systems)				P	P	S	S	S	S	S
SINGLE-DISC CD PLAYER	0	0	0	0	0	0	0	0	0	0
SIRIUSXM[®] SATELLITE RADIO[®] — Included with Popular Equipment Group	P	P	0	S	S	S	S	S	S	S
SIRIUSXM TRAFFIC[®] — Included with Uconnect 8.4AN system				P	P	P	P	P	P	P
SIRIUSXM TRAVEL LINK[®] — Included with Uconnect 8.4AN system				P	P	P	P	P	P	P
SPEAKER SYSTEM — Six, standard	S	S	S	S	S	S	S	S	S	S
— Premium I; seven speakers and eight-channel amplifier (Regular Cab only)								S		
— Premium II; 10 speakers including a subwoofer and 12-channel amplifier (included with Sport Premium Group; Quad Cab and Crew Cab models only)				0	0	P	S	S	S	S
SYSTEM CONTROLS — Steering wheel-mounted audio controls (included with leather-wrapped steering wheel)					S	S	S	S	S	S
UCONNECT ACCESS[®] — Requires Uconnect 8.4A or 8.4AN systems				P	P	S	S	S	S	S
UCONNECT ACCESS[®] VIA MOBILE SMARTPHONE — Requires Uconnect 8.4A or 8.4AN systems				0	0	0	0	0	0	0
UCONNECT BLUETOOTH[®] CONNECTIVITY — Includes hands-free phone [®] Streaming Audio, Voice Command [®] and Text Message Reader [®] (requires Uconnect 5.0, 8.4A or 8.4AN systems)	P	P	P	S	S	S	S	S	S	S
UCONNECT SYSTEMS — Uconnect 3.0 AM/FM	S	S	S							
— Uconnect 5.0 AM/FM/Bluetooth (included with Black Express Group)	0	0/P	0	S	S					
— Uconnect 8.4A AM/FM/Bluetooth/Access [®]				0	0	S	S	S	S	S
— Uconnect 8.4AN AM/FM/Bluetooth/Access [®] /NAV				0	0	0	0	0	S	S

	TRADSMAN REG/QUAD/CREW	EXPRESS REG/QUAD/CREW	HFE REG	SLT REG/QUAD/CREW	BIGHORN/ONE STAR REG/QUAD/CREW	OUTDOORSMAN QUAD/CREW	SPORT REG/QUAD/CREW	LARAME QUAD/CREW	LARAME LONGHORN CREW	LARAME LIMITED CREW
CPOS PACKAGE										
SAFETY AND SECURITY										
AIR BAGS[®] — Advanced multistage front	S	S	S	S	S	S	S	S	S	S
— Supplemental side-curtain	S	S	S	S	S	S	S	S	S	S
— Supplemental front-seat side-mounted	S	S	S	S	S	S	S	S	S	S
BRAKES — Power-assisted 4-wheel antilock disc	S	S	S	S	S	S	S	S	S	S
ELECTRONIC STABILITY CONTROL (ESC)[®] — Includes 4-wheel ABS, Brake Assist, All-Speed Traction Control, Rain Brake Support, Ready Alert Braking, Electronic Roll Mitigation, Hill Start Assist and Trailer Sway Damping [®]	S	S	S	S	S	S	S	S	S	S
PARKSENSE[®] FRONT AND REAR PARK ASSIST[®] — Not available on Regular Cab (included with Rear Camera and Park Assist Group)				0	0	0	0	0	S	S
PARKVIEW[®] REAR BACK-UP CAMERA[®] — With dynamic grid lines (grid lines not available with Uconnect 3.0 radio)	0	0		0	0/P	0/P	S	S	S	S
REMOTE KEYLESS ENTRY WITH ALLSECURE[®] — Controls for power door locks, tailgate and RamBox [®] System (when equipped), illuminated entry system, panic alarm; includes two transmitters (included with Popular Equipment Group and Power and Remote Entry Group)	P	P		S	S	S	S	S	S	S
REMOTE START SYSTEM — Included with Remote Start and Security Group					P	S	P	0	S	S
SECURITY ALARM — Included with Remote Start and Security Group					P	S	P	S	S	S
TRAILER BRAKE CONTROL — Fully integrated electronic (included with Trailer Tow Group)	0/P	0/P	0/P	P	0/P	0/P	0/P	0/P	0/P	0/P
PACKAGES / EQUIPMENT GROUPS										
BLACK EXPRESS GROUP — Includes Popular Equipment Group, Power and Remote Entry Group, door and fender badge delete, Black tailgate badges, Sport projector headlamps, Sport LED taillamps, Black painted grille, Uconnect 5.0 radio and 20-inch Black painted wheels		0								
COMFORT GROUP — Includes heated cloth seats and heated steering wheel					0	S				
CONVENIENCE GROUP — Includes Passive Entry/Keyless Enter 'n Go [™] rain-sensing wipers and Auto High-Beam Headlamp Control						0	0	0	0	S
EXTERIOR APPEARANCE GROUP — Includes chrome front and rear bumpers, chrome grille surround and 17-inch painted aluminum wheels	0									
LIMITED APPEARANCE GROUP — Includes chrome bodyside moldings, body-color wheel flares and chrome front and rear bumpers										0
LUXURY GROUP — Includes switchable dome lamp, ashtray lamp, glove box lamp, underhood lamp, illuminated vanity mirror, auto day/night mirror, exterior mirrors with signal and puddle lamps, overhead console with Universal Garage Door Opener, leather-wrapped steering wheel, full-color 7-inch TFT programmable EVIC screen					0	S	S			
MOSSY OAK[®] PACKAGE — Crew Cab 4x4 only - includes Mossy Oak logo on the seatbacks, decal on rear box side; camouflage pattern on exterior bed rail caps, tailgate caps, interior instrument panel center stack and door panel inserts; embroidered logo on four primary headrests (requires Canyon Brown/Light Frost Beige interior)						0				
POPULAR EQUIPMENT GROUP — Includes cloth 40/20/40 bench seat, carpeted flooring, remote keyless entry, floor mats and SiriusXM Satellite Radio [®]	0	0								
POWER AND REMOTE ENTRY GROUP — Includes premium vinyl door trim, remote keyless entry, foldaway Black power heated mirrors, power windows with front one-touch down and power locks (Regular Cab only)	0	0								
PROTECTION GROUP — Includes tow hooks, front suspension and transfer case skid plates (4x4 models only)	0				0	S		0	0	
REAR CAMERA AND PARK ASSIST GROUP — Includes ParkSense Front and Rear Park Assist [®] and ParkView Rear Back-Up Camera [®]					0	0				
REMOTE START AND SECURITY GROUP — Includes security alarm and Remote Start System					0	S	0			
R/T PACKAGE — Includes 3.92 axle ratio and antisip differential, P285/45R22 BSW All-Season tires, 22 x 9-inch forged polished aluminum wheels and Sport performance hood (Regular Cab 4x2 6'4" box models only)								S		
SPORT PREMIUM GROUP — Includes Premium Surround Sound Speaker System (Quad Cab and Crew Cab only)								0		
TRAILER TOW GROUP — Includes electronic trailer brake controller, Class IV hitch receiver and 7 x 11-inch trailer tow mirrors (included with Trailer and Traction Group)	0	0		P	0	0	0	0	0	0
TRAILER AND TRACTION GROUP — Includes Trailer Tow Group, 3.92 axle ratio with HEMI [®] V8 or EcoDiesel V6, or 3.55 axle ratio with Pentastar [®] V6				0						

S = Standard. 0 = Optional. P = Part of package. -- = Not available.
 Note: some features and/or applications may be late availability.
 *Lone Star model only available in Texas.

RAM 1500 SPECIFICATIONS

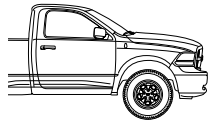

REGULAR CAB

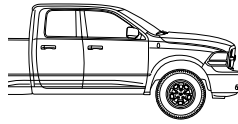

QUAD CAB®

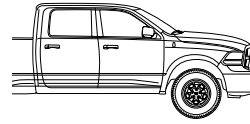

CREW CAB

RAM 1500 TOWING—SAE J2807 COMPLIANT

Maximum loaded trailer weight (when properly equipped)			REGULAR CAB				QUAD CAB®		CREW CAB			
			6'4" BOX		8' BOX		6'4" BOX		5'7" BOX		6'4" BOX	
POWERTRAIN	AXLE RATIO	GCWR	4x2	4x4	4x2	4x4	4x2	4x4	4x2	4x4	4x2	4x4
3.6L PENTASTAR® V6 / 8-SPEED AUTO	3.21	9,850	4,980	4,770	4,790	4,610	4,620	4,450	4,490	4,190		
	3.55	12,200	7,310	7,060								
	3.55	12,400			7,280	7,110						
	3.55	12,900					7,600	7,440	7,480	7,180		
3.0L ECODIESEL V6 / 8-SPEED AUTO	3.55	13,750			8,240	8,030	7,950	7,690	7,840	7,660	7,880	7,590
	3.92	13,750			8,240	8,030	7,950	7,690	7,840	7,660	7,880	7,590
	3.92	14,550										8,390
	3.92	14,750			9,200	9,030	8,950	8,690	8,840	8,560	8,880	
5.7L HEMI® V8 / 6-SPEED AUTO	3.21	12,350	7,160		7,050		6,790		6,770		6,740	
	3.92	14,325	9,140	8,970								
	3.55	14,400		9,050	9,100	8,880	8,840	8,670	8,820	8,610	8,790	8,550
	3.92	15,950			10,650	10,430	10,390	10,220	10,370	10,160	10,340	10,100
5.7L HEMI V8 / 8-SPEED AUTO	3.21	13,800	8,630	8,420	8,490	8,300	8,210	8,060	8,170	8,000	8,070	7,800
	3.92	14,350	9,180	8,970								
	3.92	15,950			10,640	10,450	10,360	10,210	10,320	10,150	10,220	9,850

RAM 1500 PAYLOAD

Maximum payload capacities (when properly equipped)			REGULAR CAB				QUAD CAB®		CREW CAB			
			6'4" BOX		8' BOX		6'4" BOX		5'7" BOX		6'4" BOX	
POWERTRAIN	GVWR	4x2	4x4	4x2	4x4	4x2	4x4	4x2	4x4	4x2	4x4	
3.6L PENTASTAR® V6 / 8-SPEED AUTO	6,010	1,450										
	6,025	1,520										
	6,300		1,580									
	6,600			1,900	1,710							
	6,800					1,900	1,720	1,850	1,650			
3.0L ECODIESEL V6 / 8-SPEED AUTO	6,600			1,500	1,290							
	6,950					1,610	1,400	1,540	1,340	1,480	1,270	
	6,350	1,610	1,430									
5.7L HEMI® V8 / 6-SPEED AUTO	6,600			1,720	1,500							
	6,900					1,820	1,600	1,770	1,550	1,710	1,520	
	6,350	1,600	1,430									
5.7L HEMI V8 / 8-SPEED AUTO	6,600			1,710	1,510							
	6,900					1,780	1,600	1,710	1,530	1,660	1,480	

Numbers in **Black boxes** reflect max ratings. 1. Payload and Max Trailer Weights are estimated values. 2. All weights are shown in lb unless otherwise stated. 3. Payload and Max Trailer Weight values are rounded to the nearest 10 lb. 4. Payload = GVWR – Base Weight. 5. Trailer Weight Rating and Tow Vehicle Trailing Weight are calculated as specified in SAE J2807. 6. Payload and Trailer Weight Rating are mutually exclusive. 7. GAWRs, GVWRs and GCWRs should never be exceeded. 8. The recommended tongue weight for a conventional hitch is 10 percent of the gross trailer weight. The maximum tongue weight for Class IV receiver hitch is limited to 1,100 lb. 9. Weight Distributing Hitch is recommended for trailers over 5,000 lb.

RAM 1500 INTERIOR DIMENSIONS

All dimensions are in inches (millimeters) unless otherwise noted.	REGULAR CAB	QUAD CAB®	CREW CAB
SEATING CAPACITY, FRONT/REAR	3 / 0 or 2 / 0	3 / 3 or 2 / 3	3 / 3 or 2 / 3
FRONT			
HEAD ROOM	39.9 (1013.5)	41.0 (1041.4)	41.0 (1041.4)
LEG ROOM	41.0 (1041.4)	41.0 (1041.4)	41.0 (1041.4)
SHOULDER ROOM	66.0 (1676.4)	66.0 (1676.4)	66.0 (1676.4)
HIP ROOM	62.9 (1598.7)	63.2 (1605.3)	63.2 (1605.3)
REAR			
HEAD ROOM	N/A	39.7 (1008.4)	39.9 (1013.5)
LEG ROOM	N/A	34.7 (880.9)	40.3 (1023.3)
SHOULDER ROOM	N/A	65.7 (1668.8)	65.7 (1668.8)
HIP ROOM	N/A	62.9 (1598.3)	63.2 (1605.3)
INTERIOR VOLUME			
FRONT cu ft (cu m)	62.5 (1.8)	64.2 (1.8)	64.2 (1.8)
REAR cu ft (cu m)	N/A	52.4 (1.5)	61.1 (1.7)
TOTAL PASSENGER VOLUME (cu ft)	62.5	116.6	125.3

RAM 1500 EXTERIOR DIMENSIONS

All dimensions are for base models only, in inches unless otherwise noted.	REGULAR CAB		QUAD CAB®	CREW CAB	
	6'4" BOX	8' BOX	6'4" BOX	5'7" BOX	6'4" BOX
OVERALL BODY WIDTH	79.4	79.4	79.4	79.4	79.4
OVERALL HEIGHT (4x2 / 4x4)	74.6 / 75.2	74.4 / 75.0	77.2 / 77.7	76.9 / 77.5	76.8 / 77.4
OVERALL LENGTH	209.0	231.0	229.0	229.0	237.9
TRACK — FRONT (4x2 / 4x4)	68.0 / 68.2	68.0 / 68.2	68.0 / 68.2	68.0 / 68.2	68.0 / 68.2
TRACK — REAR (4x2 / 4x4)	67.5 / 67.5	67.5 / 67.5	67.5 / 67.5	67.5 / 67.5	67.5 / 67.5
WHEELBASE	120.5	140.5	140.5	140.5	149.4
BED HEIGHT	20.1	20.2	20.1	20.0	20.1
BED LENGTH	76.3	98.3	76.3	67.4	76.3
BED WIDTH, WALL-TO-WALL	66.4	66.4	66.4	66.4	66.4
BED WIDTH, BETWEEN WHEELHOUSINGS	51.0	51.0	51.0	51.0	51.0



[1] Based on latest available competitive information. Class based on light-duty pickups. [2] Transferable. See dealer for complete details and a copy of the 5-Year/100,000-Mile Powertrain Limited Warranty. [3] Based on Standard Pickup class. EPA estimated mpg based on 3.6L V6 4x2. Actual results may vary. [4] Based on Standard Pickup class. EPA estimated 28 mpg highway based on EcoDiesel V6 4x2. Actual results may vary. [5] No system, no matter how sophisticated, can repeal the laws of physics or overcome careless driving actions. Performance is limited by available traction, which snow, ice and other conditions can affect. When the ESC warning lamp flashes, the driver needs to use less throttle and adapt speed and driving behavior to prevailing road conditions. Always drive carefully, consistent with conditions. Always wear your seat belt. [6] Always look before proceeding, electronic drive aid is not a substitute for conscientious driving; always be aware of your surroundings. [7] WiFi subscription required. Vehicle must be registered with Uconnect Access and fulfill minimum subscription requirements. Vehicle must be properly equipped and in active and usable cellular range for WiFi usage. WiFi Hotspot does not enable direct communication between multiple in-vehicle devices. Factors affecting the performance of WiFi Hotspot include: cellular network, signal strength and quality, time of day, number of channels used by the service provider, type of connection, number of clients using WiFi Hotspot and client device. This feature is not intended for use by the driver while the vehicle is in motion. Always drive safely. [8] Requires a mobile phone equipped with the Bluetooth Hands-Free Profile. Visit UconnectPhone.com for system and device compatibility. [9] SiriusXM audio and data services each require a subscription after the trial included with the new vehicle purchase, sold separately or as a package, by SiriusXM Radio Inc. **If you decide to continue service after your trial, the subscription plan you choose will automatically renew thereafter and you will be charged according to your chosen payment method at then-current rates.** Fees and taxes apply. **To cancel you must call SiriusXM at 1-866-635-2349. See SiriusXM Customer Agreement for complete terms at siriusxm.com.** All fees and programming subject to change. © 2014 SiriusXM Radio Inc. Sirius, XM and all related marks and logos are trademarks of Sirius XM Radio Inc. [10] Uconnect Access is available only on equipped vehicles purchased within the contiguous United States and AK. Services can only be used where coverage is available, see coverage map for details. For a complete list of Uconnect Access services, please visit http://www.driveuconnect.com/features/uconnect_access/packages. [11] Your new vehicle may come with an included trial period for use of the Uconnect Access Services. Your trial begins the day you take delivery of your vehicle, so register as soon as possible. To activate the trial, you must register with Uconnect Access. [12] Vehicle must be within the United States, have network coverage and must be registered with Uconnect Access with an active subscription that includes the applicable feature and you must fulfill minimum subscription requirements. It must also be equipped with features that enable remote commands, such as keyless entry, and must be in active and usable cellular range. The Uconnect Access App must be installed and launched on your mobile device to use these remote commands. Remote features are available only on vehicles that are properly equipped. Check state and local laws regarding the use of remote start systems. [13] Voice Text Reply and Voice Texting features require a compatible mobile device enabled with Bluetooth Message Access Profile (MAP). iPhone and some other smartphones do not currently support Bluetooth MAP. Visit UconnectPhone.com for system and device compatibility. Ensure MAP is ON and incoming message notification is enabled. Vehicle must be registered for Uconnect Access and you must fulfill minimum subscription requirements. Also requires the use of a compatible smartphone that supports text messaging and Bluetooth. Visit UconnectPhone.com for system and device compatibility. [14] The 9-1-1 Call button will connect you directly with Emergency Assistance. If you accidentally press the button, you have 10 seconds to cancel the call by either pressing the 9-1-1 button on the rearview mirror or the Cancel button on the Uconnect touchscreen. [15] Provides direct dial access to Roadside Assistance Service. Vehicle must be within the United States, have network coverage and must be registered with Uconnect Access with an active subscription that includes the applicable feature. Additional roadside assistance charges may apply. Check warranty for details. [16] If you have this feature and have reported your vehicle as stolen to an appropriate law enforcement agency, Uconnect will try to locate your vehicle after receiving proper documents and once law enforcement contacts Uconnect Customer Care. Uconnect may refuse to locate your vehicle if you do not provide the requested information or documents. Always notify law enforcement if your vehicle is stolen and do not attempt to recover it on your own. [17] Vehicle must be registered with Uconnect Access and fulfill minimum subscription requirements. Vehicle must also be properly equipped and in an active and usable cellular range. Theft Alarm Notification is only available on factory-installed alarms. [18] The Advanced Front Air Bags in this vehicle are certified to the new U.S. Federal regulations for advanced air bags. Children 12 years old and younger should always ride buckled up in a rear seat. Infants in rear-facing child restraints should never ride in the front seat of a vehicle with a passenger front air bag. All occupants should always wear their lap and shoulder belts properly. [19] The SiriusXM Travel Link data displays and individual product availability vary by vehicle hardware. Not all vehicles or devices are capable of receiving all Travel Link services offered by SiriusXM; Weather Forecast, Current Conditions may not be available in all locations; and features of individual systems will vary. Images within are for representative purposes only and are not real products. For actual features and images of real products, consult the vehicle manufacturer. SiriusXM is not responsible for any errors or inaccuracies in the SiriusXM Travel Link services or their use. Our satellite service is available only to those at least 18 and older in the 48 contiguous U.S.A. and DC. Our Sirius satellite service is also available in PR (with coverage limitations). Our Internet radio service is available throughout our satellite service area and in AK and HI.

About this catalog: Since the time of printing, some of the information you'll find in this catalog may have been updated. Ask your dealer for details. Some of the equipment shown or described throughout this catalog may be available at extra cost. Specifications, descriptions, illustrative materials and all competitive comparisons contained herein are as accurate as known at the time this publication was approved for printing. Chrysler Group LLC reserves the right to discontinue models at any time or change specifications without notice or without incurring obligation. All options are required in combination with other options. For the price of the model with the equipment you desire, or verification of specifications contained here, see your Ram dealer. iPhone, iPad and iTunes are registered trademarks of Apple Inc. Bluetooth is a registered trademark of Bluetooth SIG, Inc. Mossy Oak is a registered trademark of Haas Outdoors, Inc. Bosch is a registered trademark of Robert Bosch GmbH. Sirius, XM and all related marks and logos are trademarks of SiriusXM Radio Inc. Facebook and logo are trademarks of Facebook, Inc. The Twitter logo is a service mark of Twitter, Inc. The YouTube logo is a trademark of Google Inc. Yelp is a registered trademark of Yelp. Pandora is a registered trademark of Pandora Media, Inc. All rights reserved. iHeartRadio is a registered trademark of Clear Channel Broadcasting, Inc. Slacker Radio is a registered trademark of Slacker, Inc. Aha is a trademark of Harman International. NFL is a registered trademark of the National Football League. MLB is a registered trademark of Major League Baseball. NASCAR is a registered trademark of the National Association for Stock Car Auto Racing, Inc. Danner® is a registered trademark of LaCrosse Footwear, Inc. Chrysler, Ram, the Ram's Head logo, AllSecure, Big Horn, HEMI, Laramie, Laramie Longhorn, Mopar, the Mopar Owner Connect design, Mopar Vehicle Protection, Outdoorsman, ParkSense, ParkView, Pentastar, Quad Cab, Ram 1500 Express, R/T, RamBox, TorqueFlite. Tradesman and Uconnect are registered trademarks and Active-Level, Keyless Enter 'n Go and HFE High Fuel Efficiency & Design are trademarks of Chrysler Group LLC. © 2014 Chrysler Group LLC. All rights reserved.



Join fellow Ram enthusiasts and tell your story by posting comments, participating in discussions and sharing your photos and videos. Join our community on Facebook, follow us on Twitter and check us out on YouTube.



GO MOBILE. Take a multimedia tour of your vehicle on your mobile device. Visit the Chrysler Group LLC page in iTunes® from your smartphone or iPad®. Log on to the ramtrucks.com mobile site for an at-a-glance review of what you need to know about your Ram truck. Experience visual and interactive demonstrations while gaining access to product information at your fingertips, wherever you go.

THE RAM OUTFITTER

Cool signage. Apparel. Electronics. Tools. Sports gear and business items. With your 2015 Ram 1500, you've got a world of Ram merchandise that's just a click away. It's all at **Ram Outfitter**.

Treat yourself. Find the perfect gifts for the Ram enthusiast in your life. The Ram's Head identity leaves no doubt about the truck that rules. Bookmark ramtrucks.com/outfitter



RAMTRUCKS.COM